

STANDARD 1 1/2" & 2" METER INSTALLATION & VAULT

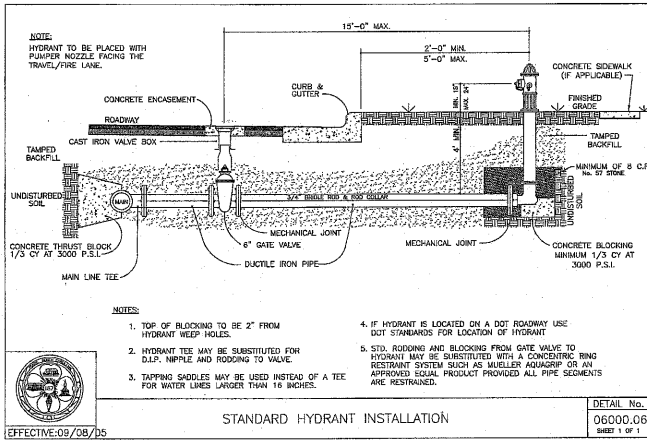

STANDARD HYDRANT INSTALLATION

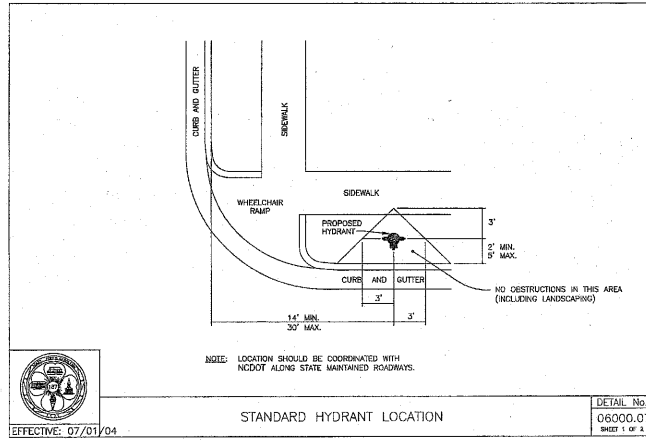

STANDARD HYDRANT LOCATION

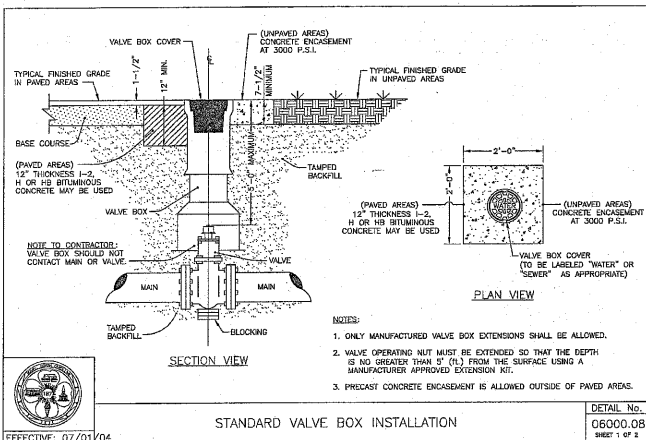

STANDARD VALVE BOX INSTALLATION

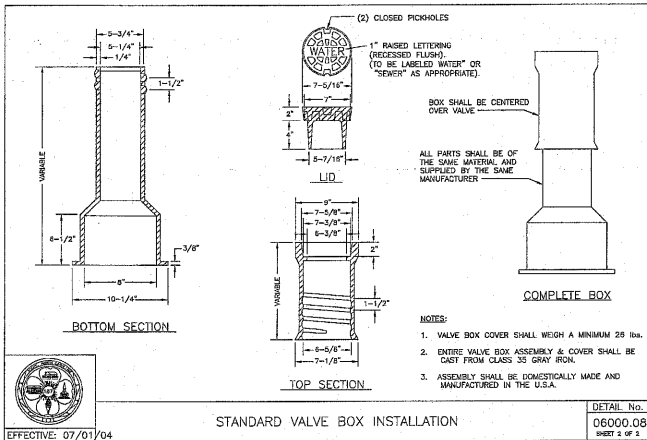

STANDARD VALVE BOX INSTALLATION

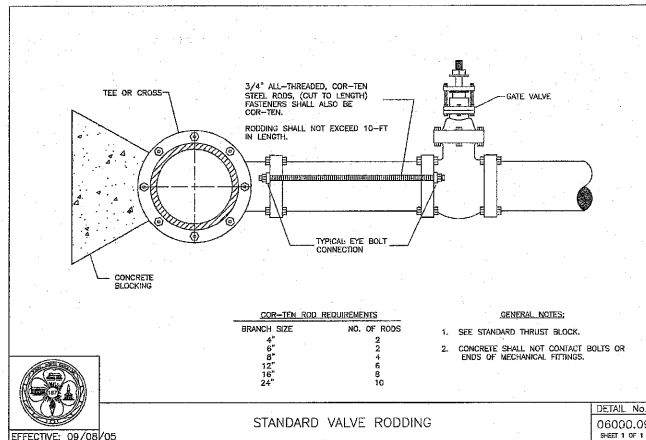

STANDARD VALVE RODGING

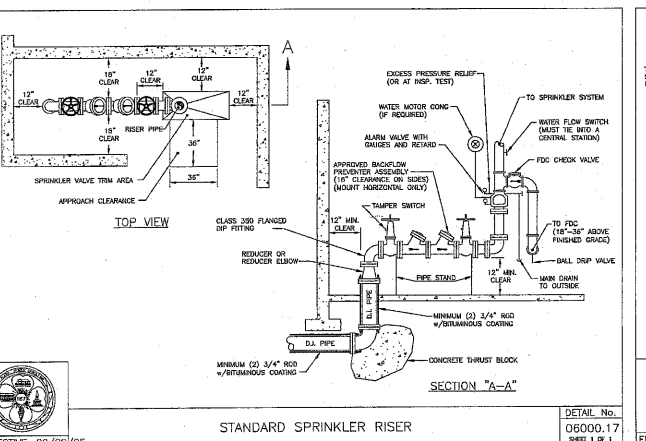

STANDARD SPRINKLER RISER

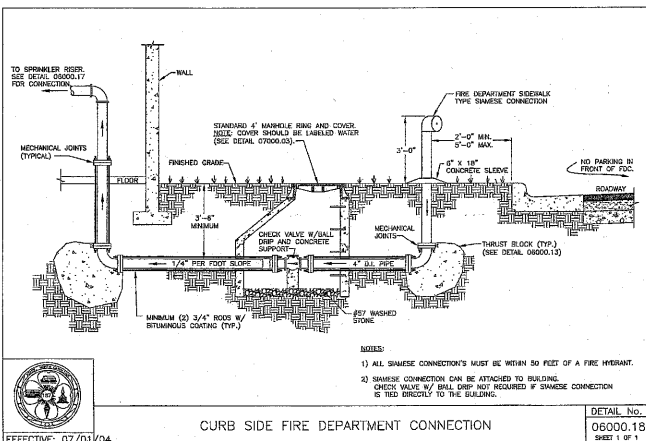

CURB SIDE FIRE DEPARTMENT CONNECTION

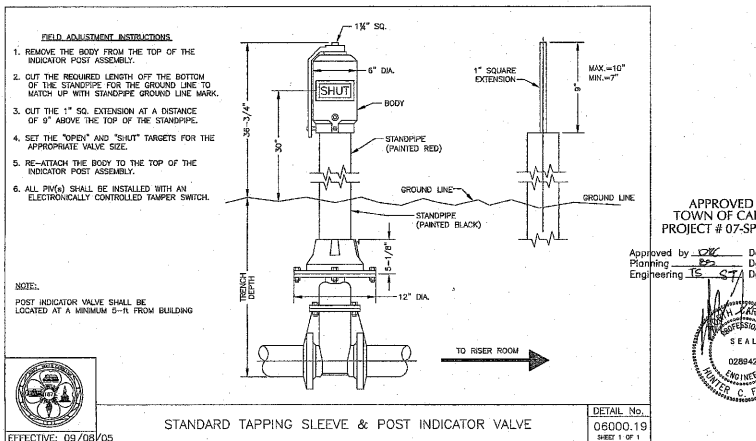

STANDARD TAPPING SLEEVE & POST INDICATOR VALVE

No.	Revision	Date	By	Design	Scale
					1"=30'
					5/21/07
					2070095.00