

V:\Projects\Sells Projects 05-4029 Amberly AR Carolina Preserve Rec Center DRAWINGS\PROJECT DRAWINGS 05-4029 C90 Details.dwg 1/10/2006 9:00:03 AM EST

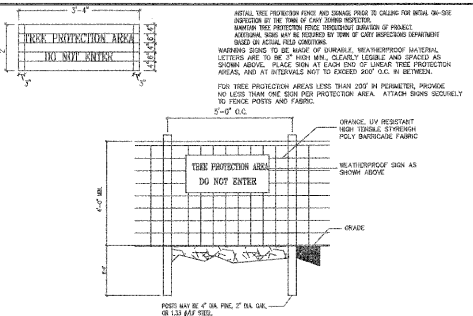

TREE PROTECTION FENCE DETAILS N.T.S.

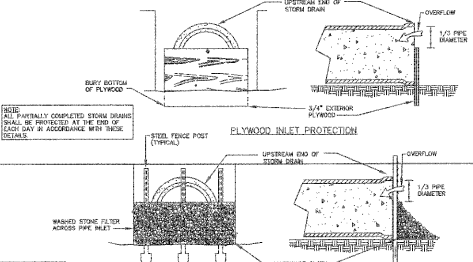

STANDARD PIPE INLET PROTECTION (PLYWOOD & STONE)

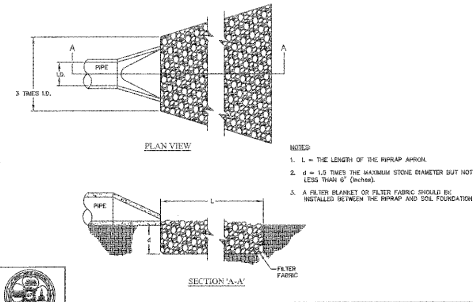

STANDARD CATCH BASIN/YARD INLET PROTECTION

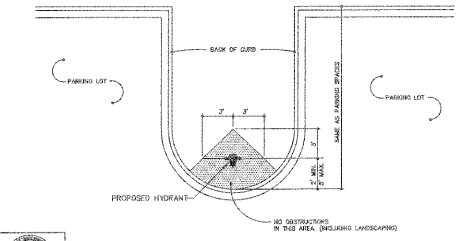

STANDARD HYDRANT LOCATION (FOR PARKING LOT)

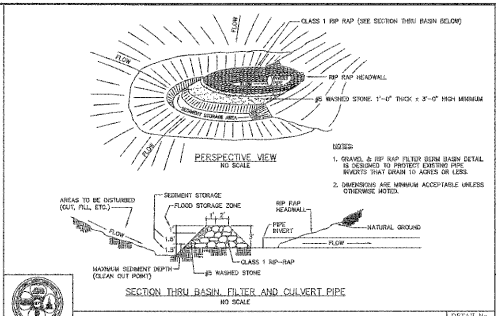

SECTION THRU BASIN FILTER AND CULVERT PIPE

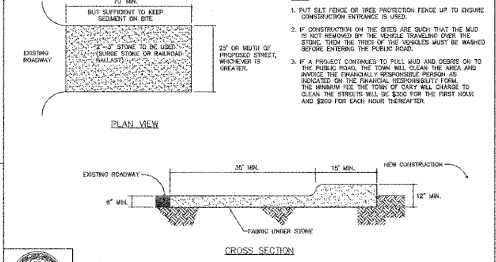

STANDARD CONSTRUCTION ENTRANCE

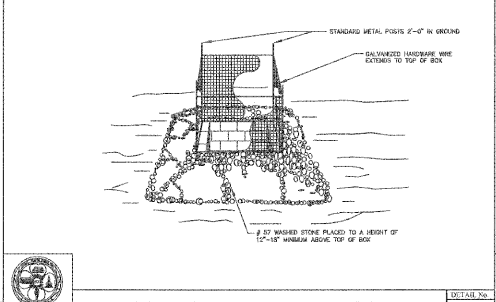

STANDARD BLOCK & GRAVEL DROP INLET PROTECTION

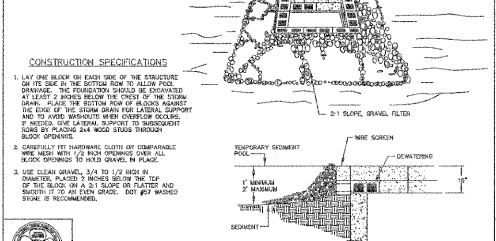

STANDARD TEMPORARY SILT FENCE

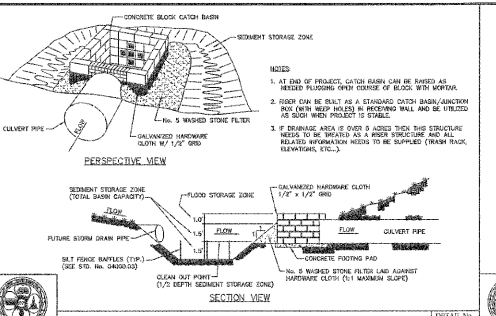

CATCH BASIN RISER/FILTER

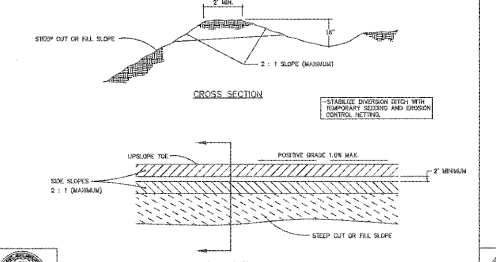

STANDARD DIVERSION DITCH

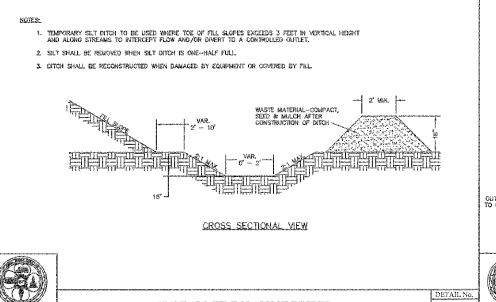

STANDARD TEMPORARY SILT DITCH

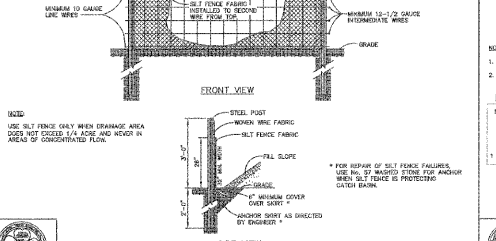

STANDARD TEMPORARY SILT FENCE

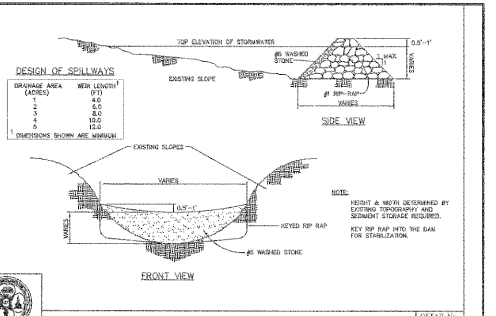

STANDARD CHECK DAM

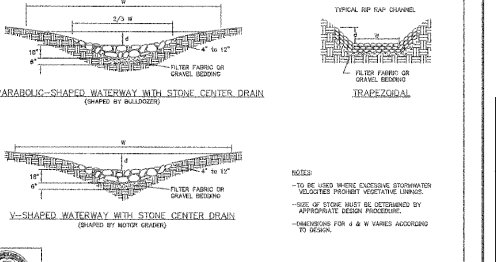

STANDARD RIP-RAP LINED CHANNELS

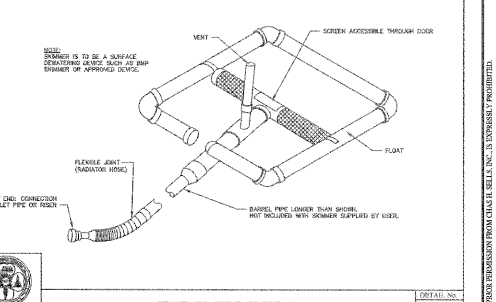

STANDARD SKIMMER DETAIL

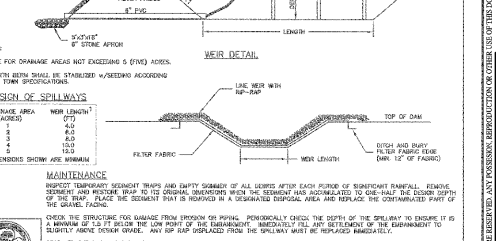

STANDARD GRAVEL & RIP-RAP FILTER BASIN

**CHAS. H. SELLS, INC.**  
 Consulting Engineers - Surveyors & Photogrammetrists  
 15401 Weston Parkway  
 Suite 250  
 Cary, NC 27513  
 Tel: 919-678-0035  
 Fax: 919-678-0206  
 www.chasells.com

**AMBERLY AR RECREATION CENTER**  
 CARY, NORTH CAROLINA  
 PULTE HOMES  
 801 Corporate Center Drive  
 Raleigh, NC 27607

PROJECT #: 05-4029 DATE: 1/10/06  
 DRAWN BY: CD CHECKED BY: ET  
 TITLE: EROSION CONTROL DETAILS  
 SHEET: C9.1

APPROVED  
 TONY OF CARY  
 Approved by: *DC* Date: 12-19-05  
 Planning: *AC* Date: 1-29-06  
 Engineering: *TS* Date: 1-19-06