

CARRIER PIPE STD. NO. 5.02

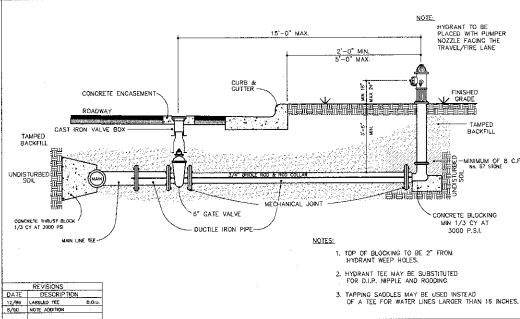

STANDARD HYDRANT INSTALLATION STD. NO. 6.06

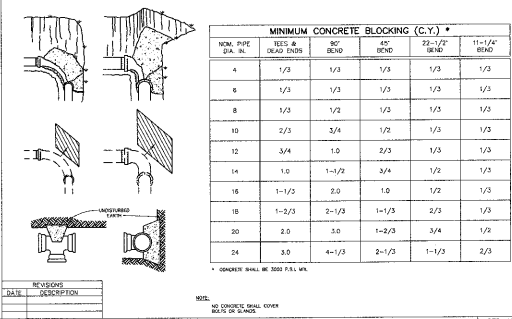

STANDARD REACTION BLOCKING STD. NO. 6.12

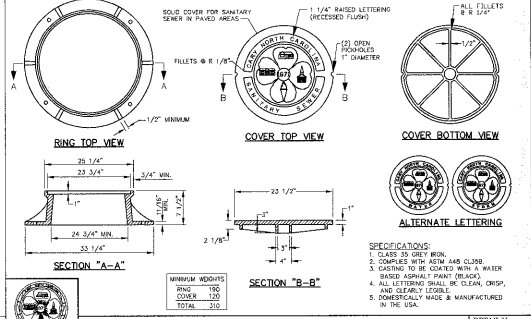

STANDARD MANHOLE RING AND COVER (TYPE I PAVED AREAS) STD. NO. 6.14

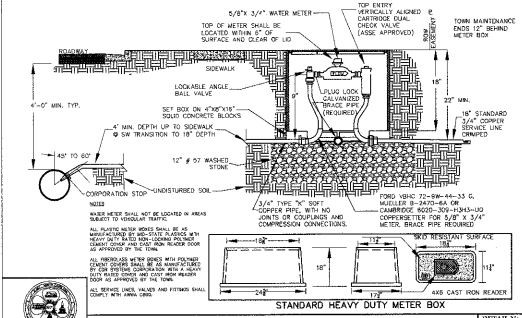

STANDARD 3/4" WATER SERVICE & METER BOX INSTALLATION DETAIL NO. 06000.01

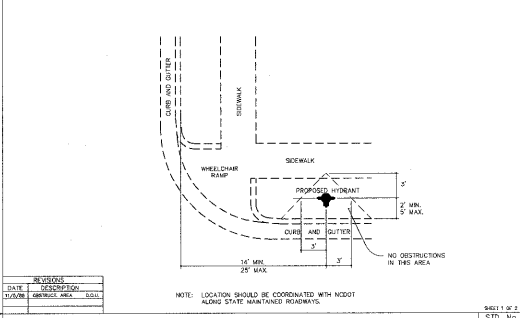

STANDARD HYDRANT LOCATION STD. NO. 6.07

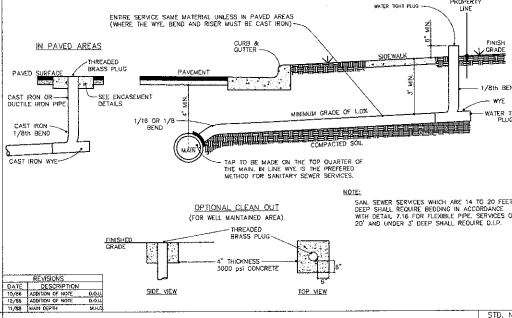

STANDARD SANITARY SEWER TAP AND SERVICE STD. NO. 7.01

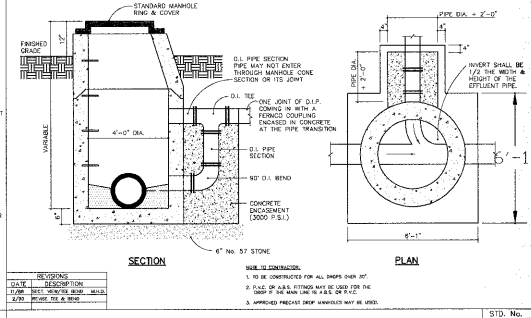

STANDARD OUTSIDE DROP MANHOLE STD. NO. 7.06

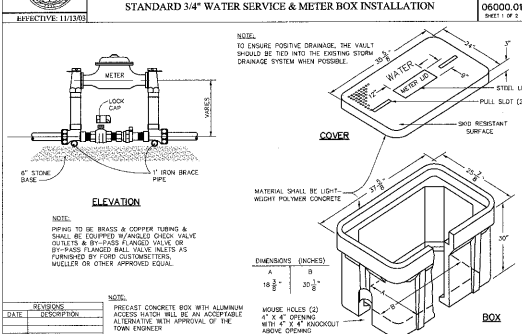

STANDARD 1-1/2" & 2" METER INSTALLATION AND VAULT STD. NO. 6.02

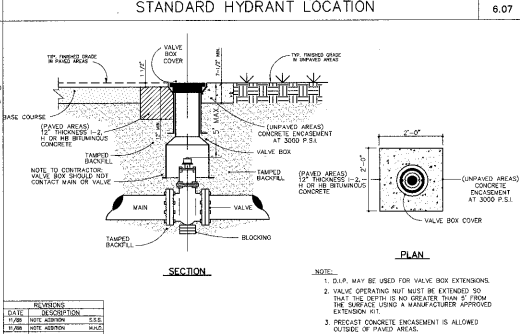

STANDARD VALVE BOX INSTALLATION STD. NO. 6.08

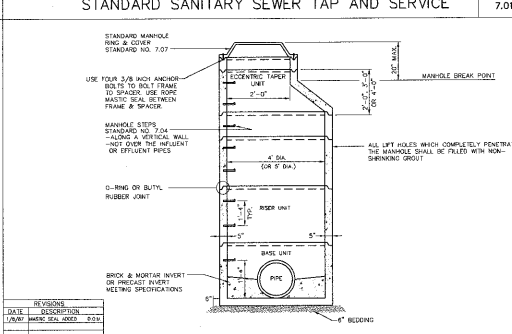

STANDARD PRECAST CONCRETE MANHOLE STD. NO. 7.03

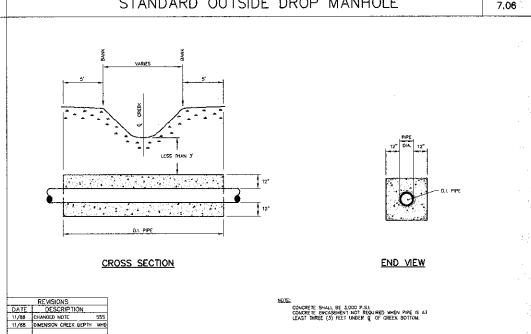

STANDARD CONCRETE ENCLOSURE FOR STREAM CROSSING STD. NO. 7.13

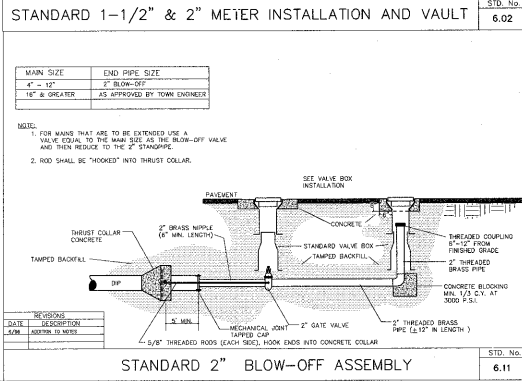

STANDARD 2" BLOW-OFF ASSEMBLY STD. NO. 6.11

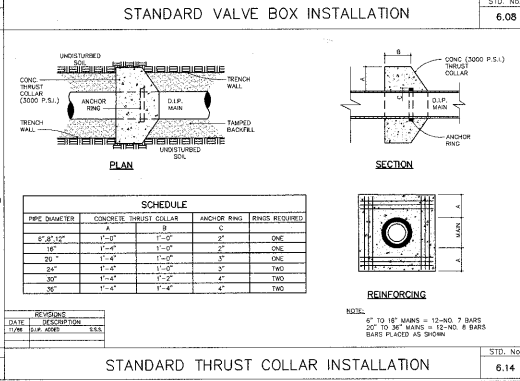

STANDARD THRUST COLLAR INSTALLATION STD. NO. 6.14

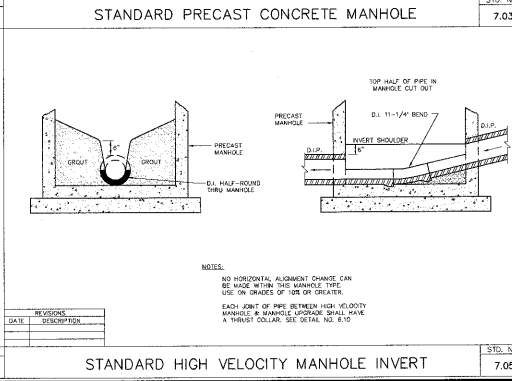

STANDARD HIGH VELOCITY MANHOLE INVERT STD. NO. 7.05

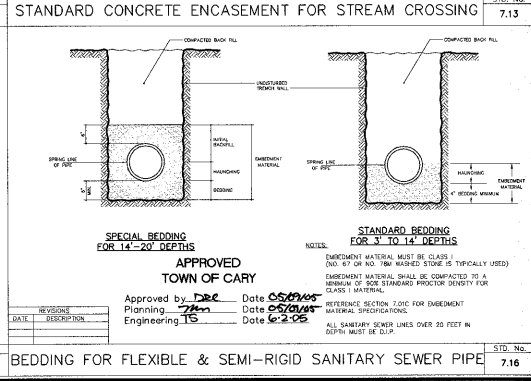

BEDDING FOR FLEXIBLE & SEMI-RIGID SANITARY SEWER PIPE STD. NO. 7.16

No.	Revision	Date	By	Designer	WBR	Scale
A	100 1st REVIEW COMMENTS	7/26/04	GAS			AS NOTED
B	100 2nd REVIEW COMMENTS	8/20/04	GAS			
C	100 3rd REVIEW COMMENTS	10/25/04	GAS			
D	100 APPROVAL	5/20/05	GAS			

Drawn By: **GAS** Date: **4/1/04**
 Checked By: **GAS** Job No: **204037**
 Date: **204037**

CARRAMORE SUBDIVISION
PHASE II

UTILITY DETAILS

WITHERS & RAVENEL
 ENGINEERS | PLANNERS | SURVEYORS

111 McMan Drive Cary, North Carolina 27511 | tel: 919-469-334