

1 PILASTER / HINGE DETAIL
 SCALE: 1" = 1'-0"
 X-HINGE

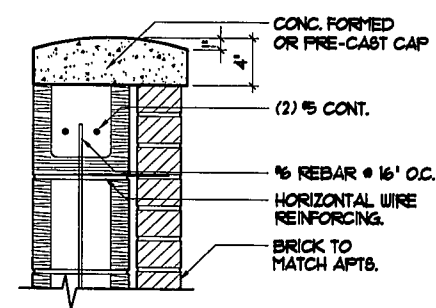

4 COMPACTOR WALL CAP
 SCALE: 1-1/2" = 1'-0"
 X-C-SEC

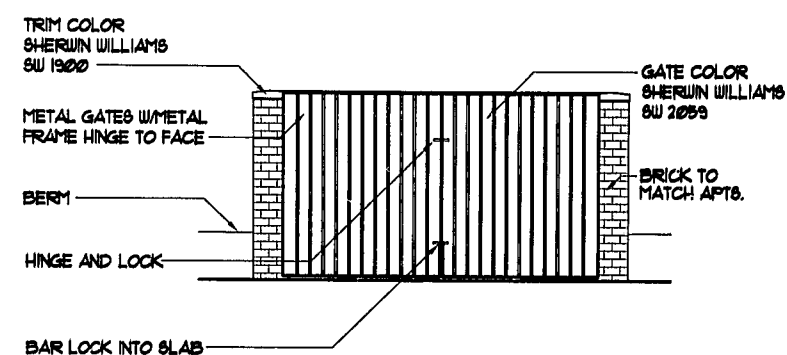

6 GATE ELEVATION
 SCALE: 1/4" = 1'-0"
 X-GATE

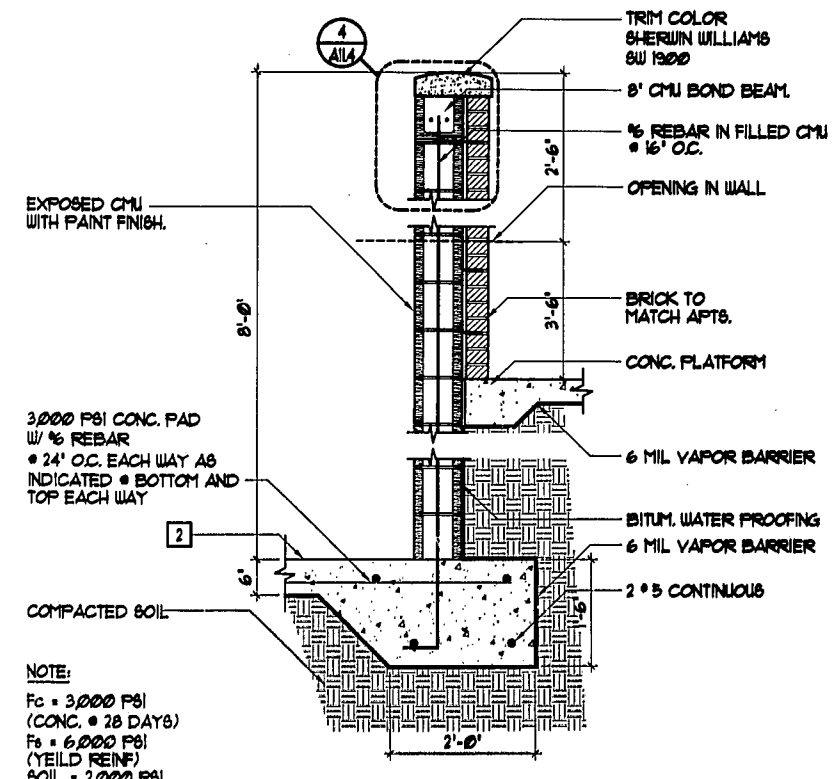

9 RETAINING WALL & COMPACTOR
 SCALE: 3/4" = 1'-0"
 X-C-SEC

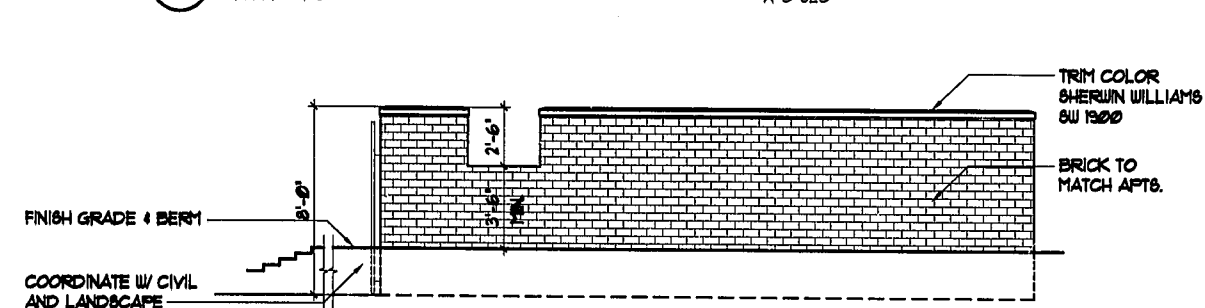

2 NOT USED
 SCALE: 1" = 1'-0"
 X-C-SEC

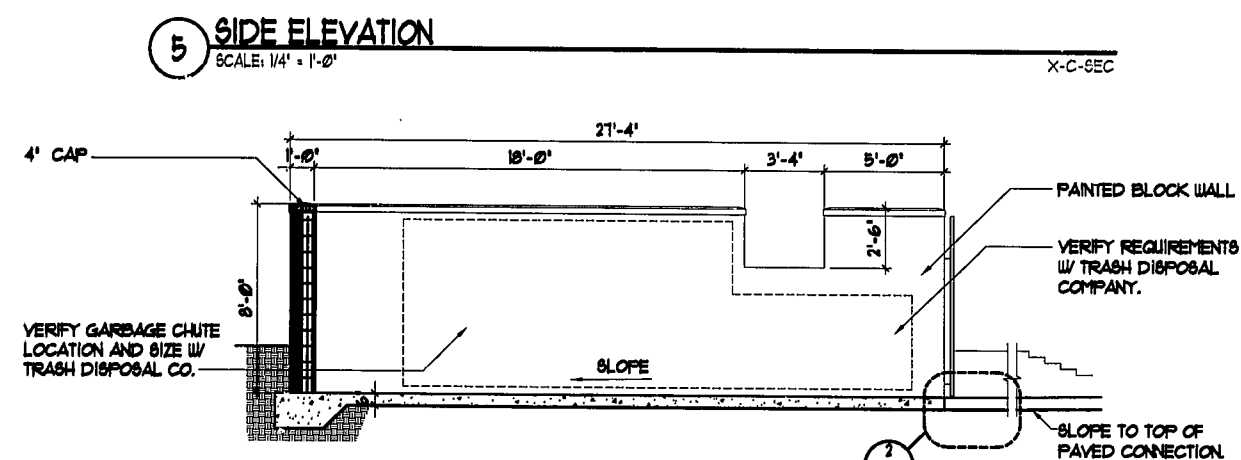

5 SIDE ELEVATION
 SCALE: 1/4" = 1'-0"
 X-C-SEC

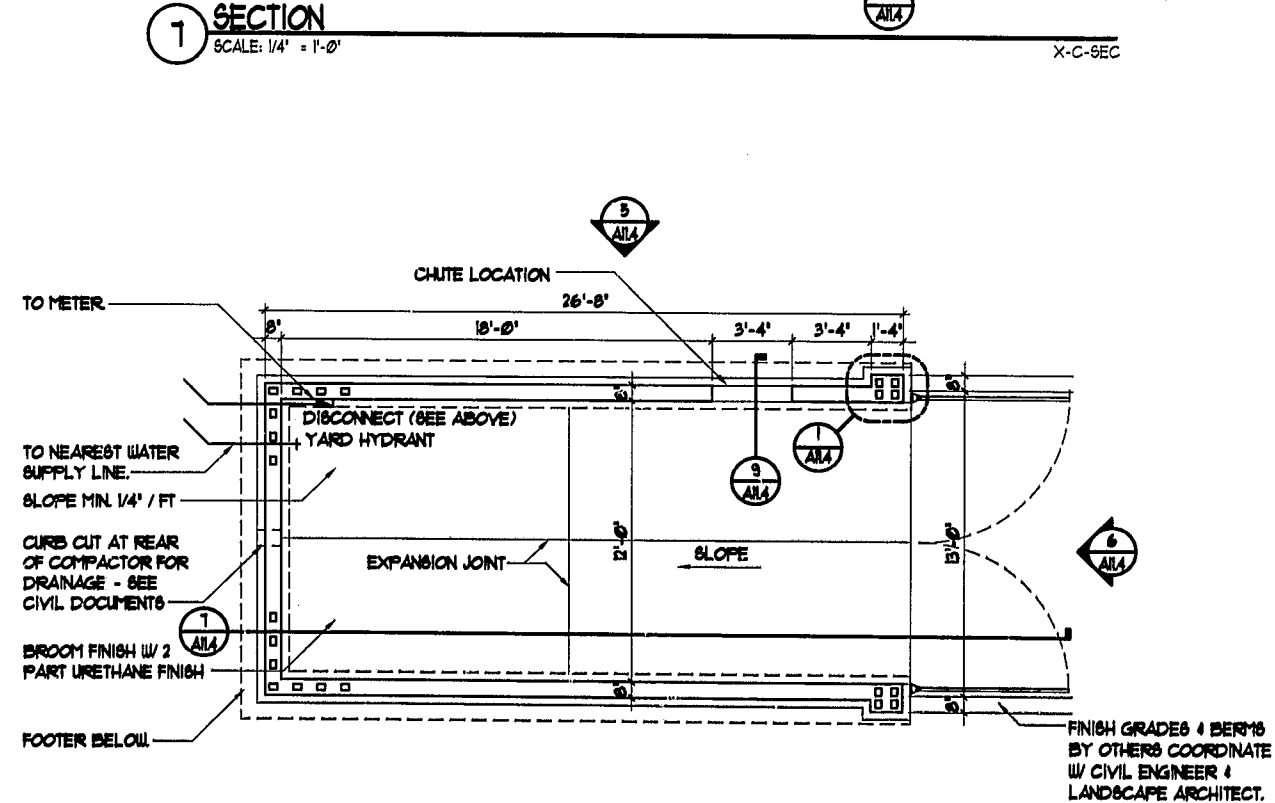

10 PLAN
 SCALE: 1/4" = 1'-0"
 X-C-PLAN

OPTION FOR ELECTRICAL SERVICE TO BE SPECIFIED BY OWNER.

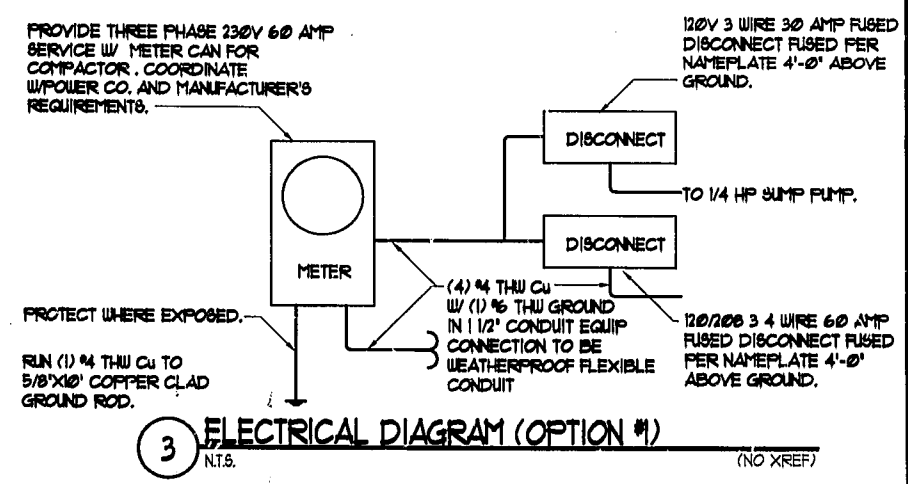

3 ELECTRICAL DIAGRAM (OPTION #1)
 N.T.S. (NO XREF)

IF THREE PHASE IS NOT AVAILABLE PROVIDE SINGLE PHASE 230V 100 AMP SERVICE W/ METER CAN FOR COMPACTOR. COORDINATE W/ POWER CO. AND MANUFACTURER'S REQUIREMENTS.

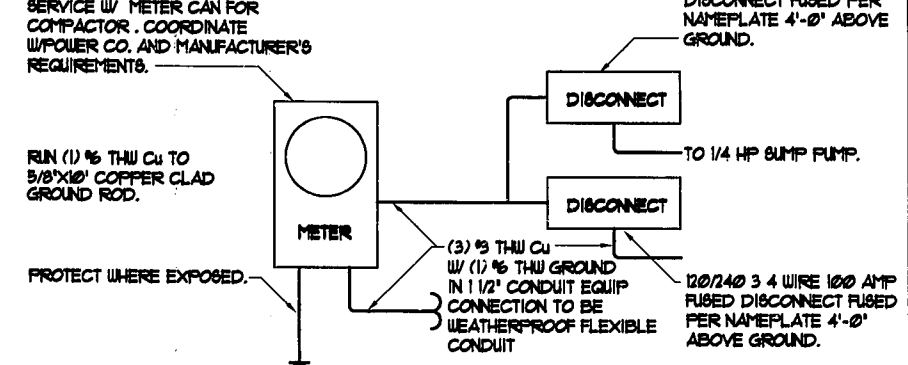

8 ELECTRICAL DIAGRAM (OPTION #2)
 N.T.S. (NO XREF)

11 COLD WATER SUPPLY
 N.T.S. (NO XREF)

GENERAL NOTES
 1 CONTRACTOR TO COORDINATE COMPACTOR ENCLOSURE, CHUTE LOCATIONS, AND GRADE ELEVATIONS WITH COMPACTOR MANUFACTURER AND CIVIL ENGINEER PRIOR TO CONSTRUCTION. CONTRACTOR TO NOTIFY ARCHITECT OF ANY CONDITION WHICH DIFFER FROM THE DRAWINGS.
 2 PROVIDE A RECESS IN COMPACTOR FLOOR COORDINATE WITH CIVIL ENGINEER.

01-50-012
 APPROVED
 TOWN OF CARY
 Approved By: [Signature] Date: 5-22-02
 Planning: [Signature] Date: 6-12-02
 Engineering: [Signature] Date: 6-12-02

REVISIONS	BY
PERMIT SET 3-26-02	

SLOCUM • PLATTS
 ARCHITECTS DESIGN STUDIO, P.A.
 RANDALL J. SLOCUM AR 13350 WILLIAM P. PLATTS AR 13262
 300 SOUTH PARK AVE., SUITE 200
 WINTER PARK, FLORIDA 32789
 TEL. (407)645-3019 FAX (407)645-2771

RANDALL J. SLOCUM
 NORTH CAROLINA 19866

FLOOR, FRAMING PLAN, ELEVATIONS AND SECTIONS
 THE GROVES AT CARY PARK
 COMPACTOR
 NORTH CAROLINA
 CARY

DRAWN	RMG
CHECKED	WFP
DATE	3-26-02
SCALE	AS NOTED
JOB NO.	01-045
SHEET	

A11.4