

MESA STANDARD UNIT
NOT TO SCALE

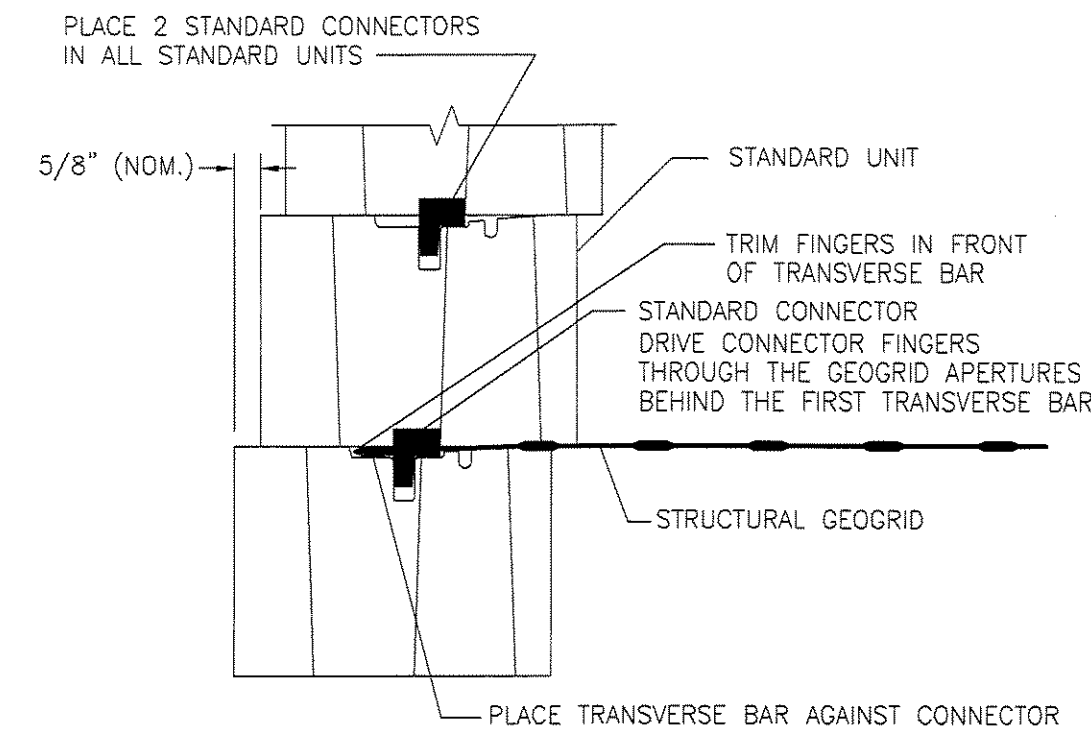

**MESA STANDARD UNIT AND
GEOGRID CONNECTION DETAIL**
NOT TO SCALE

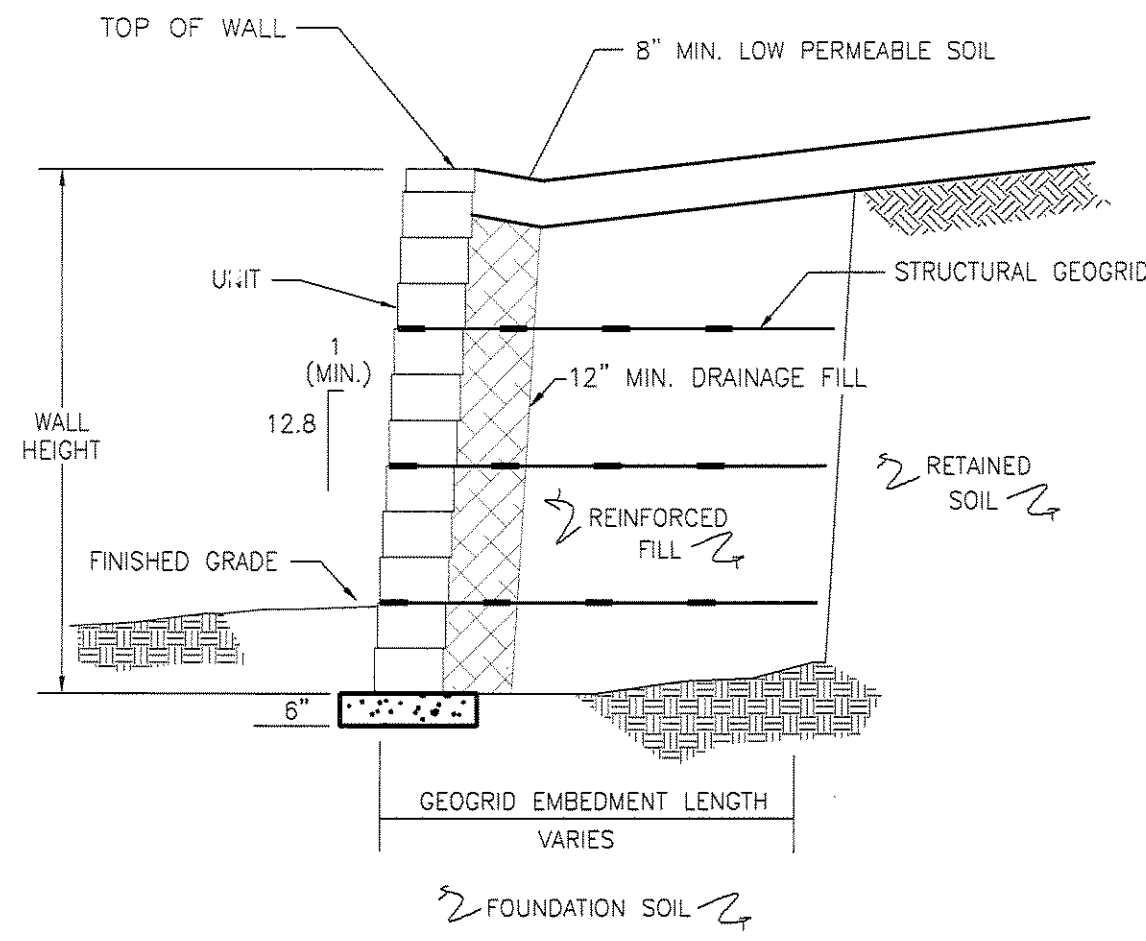

TYPICAL CROSS-SECTION
NOT TO SCALE

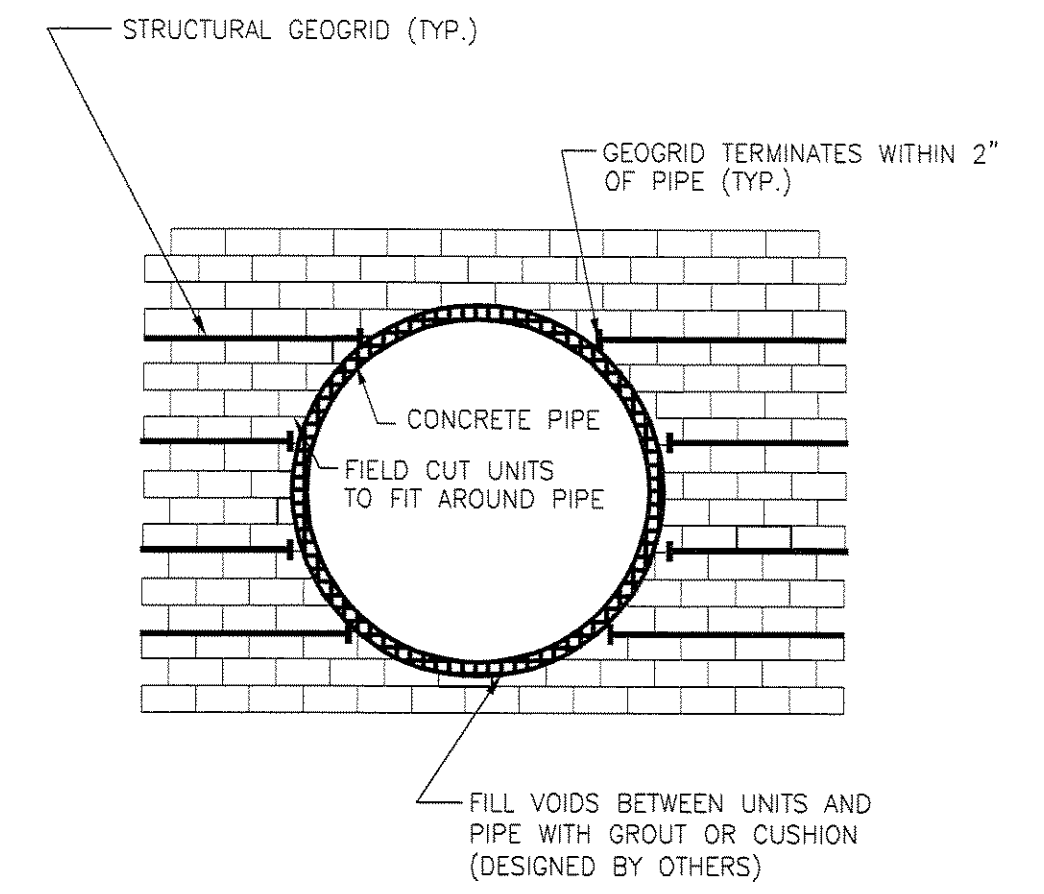

WALL DETAIL AT CONCRETE PIPE OUTLETS
NOT TO SCALE

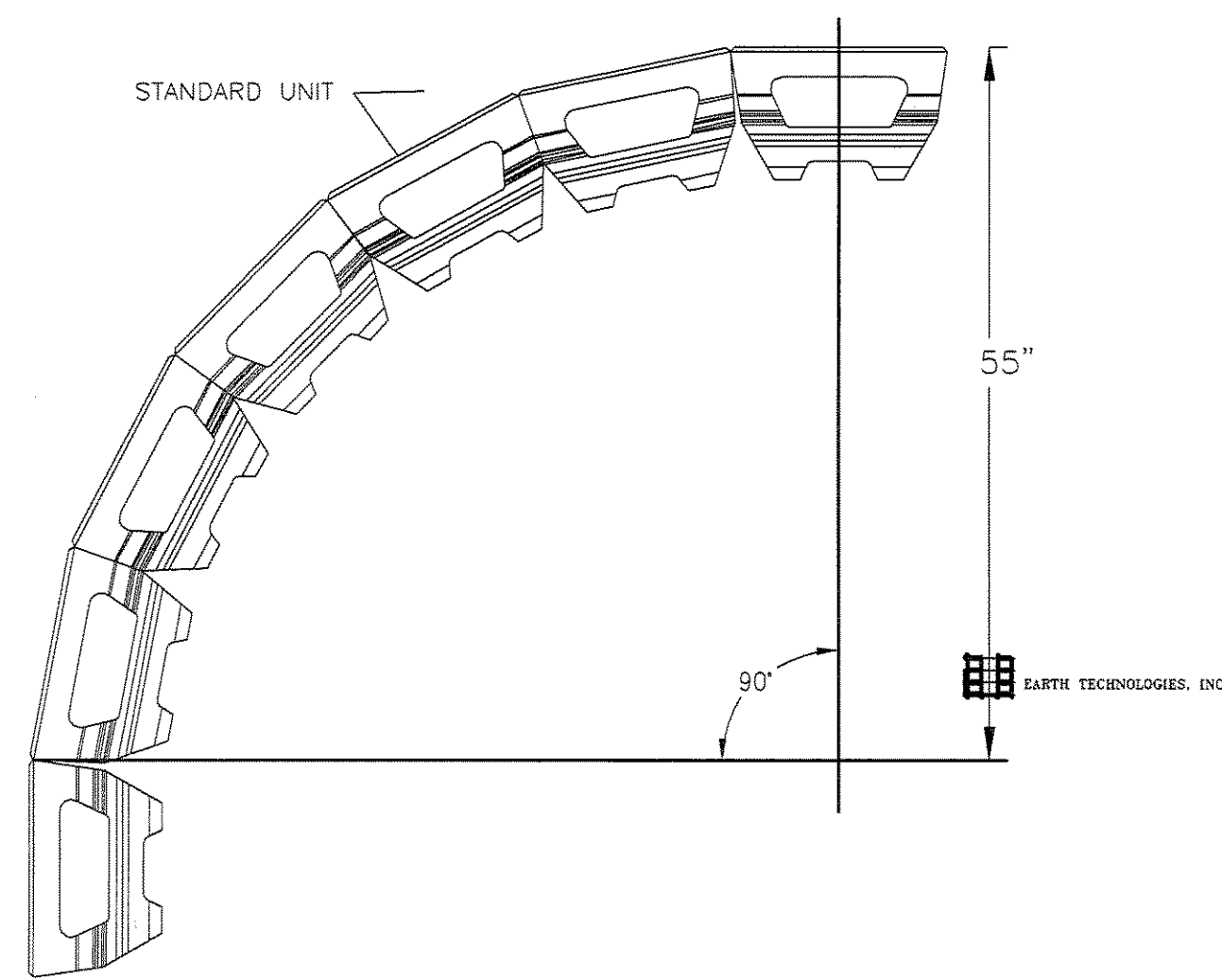

**90° CURVE DETAIL
STANDARD UNIT**
NOT TO SCALE

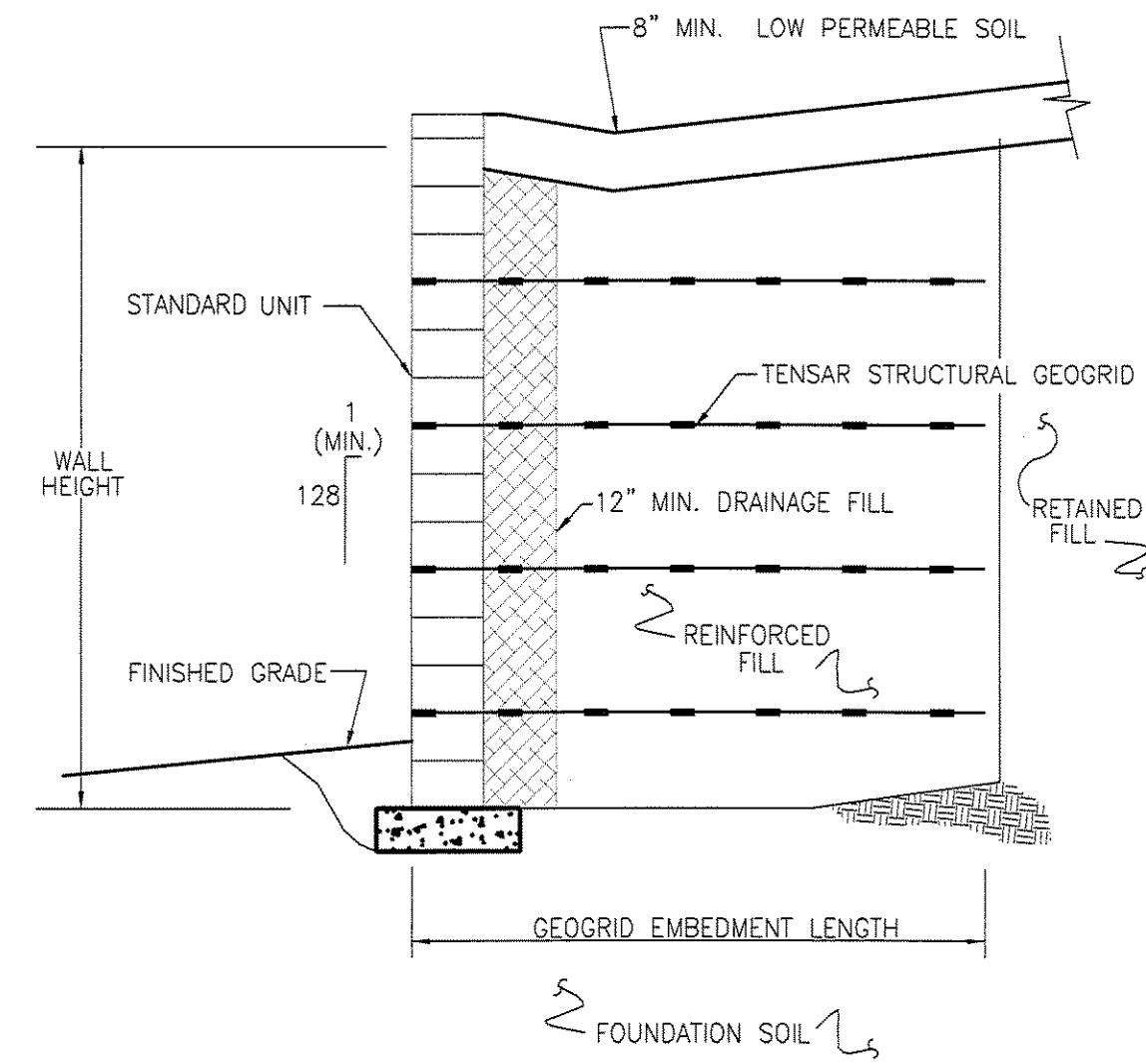

TYPICAL CROSS-SECTION
NOT TO SCALE

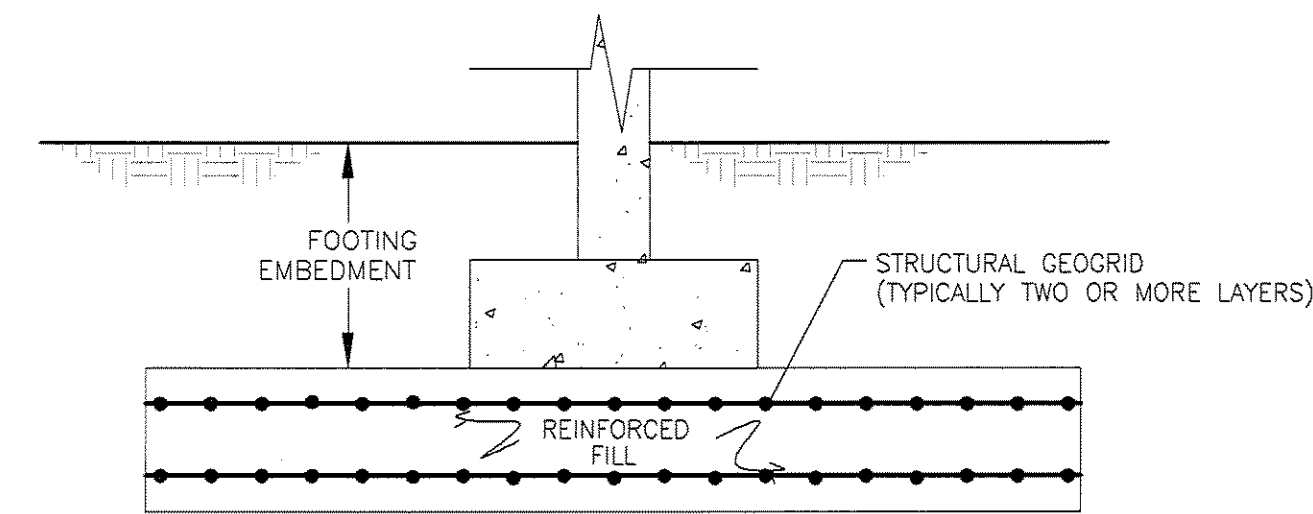

TYPICAL FOOTING CROSS-SECTION
NOT TO SCALE

NOTE:

1. THE RETAINING WALL SHALL BE A BROWN OR GREEN COLOR, SO AS TO BLEND IN WITH THE NATURAL SURROUNDINGS. ALTRIOR SHADES OF BROWN OR GREEN ARE ALLOWED, BUT SHALL BE APPROVED BY BOTH THE TOWN AND THE OWNER.

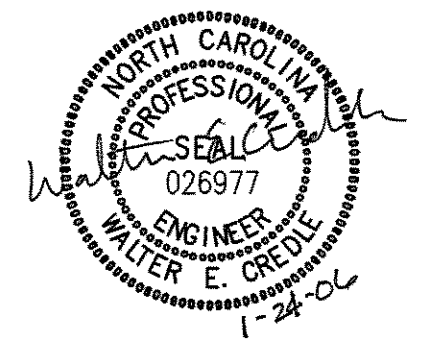

PROJECT # 05-SP-004-A
APPROVED
TOWN OF CARY

Approved by: DEC Date: 1-17-06
Planning: RP Date: 1-24-06
Engineering: TS Date: 1-27-06

No.	Revision	Date	By

Designer	W&R	Scale	NTS
Drawn By	W&R	Date	01/24/06
Checked By	WEC	Job No.	204070.1



**WESTON PLACE
WESTON PDD**

RETAINING WALL DETAILS

WITHERS & RAVENEL
ENGINEERS | PLANNERS | SURVEYORS
111 MacKenan Drive Cary, North Carolina 27511 tel: 919-469-3340 fax: 919-467-6008 www.wITHERSRAVENEL.com